

lenovo[®]

Lenovo ideapad 100-15IBD

80QQ

User Guide



Read the safety notices and important tips in the included manuals before using your computer.

Notes

- Before using the product, be sure to read *Lenovo Safety and General Information Guide* first.
- The latest electronic compliance and environmental information are available from the Lenovo compliance information Web sites.
 - To view compliance information go to:
<http://www.lenovo.com/compliance>
 - To download environmental information go to:
<http://www.lenovo.com/ecodeclaration>
- The features described in this guide are common to most models. Some features may not be available on your computer or your computer may include features that are not described in this user guide.
- The illustrations in this manual may differ from the actual product. Please refer to the actual product.

Regulatory Notice

- For details, refer to **Guides & Manuals** at <http://support.lenovo.com>.

First Edition (August 2015)

© Copyright Lenovo 2016.

LIMITED AND RESTRICTED RIGHTS NOTICE: If data or software is delivered pursuant to a General Services Administration "GSA" contract, use, reproduction, or disclosure is subject to restrictions set forth in Contract No. GS-35F-05925.

Contents

Chapter 1. Getting to know your computer	1
Top view	1
Left-side view	5
Right-side view	8
Front view	9
Bottom view	10
Chapter 2. Lenovo OneKey Recovery system	11
Chapter 3. Troubleshooting	13
Frequently asked questions	13
Troubleshooting	16
Appendix A. CRU instructions	19
Removing the keyboard	19
Removing the optical drive	21
Trademarks	23

Chapter 1. Getting to know your computer

■ ■ Top view

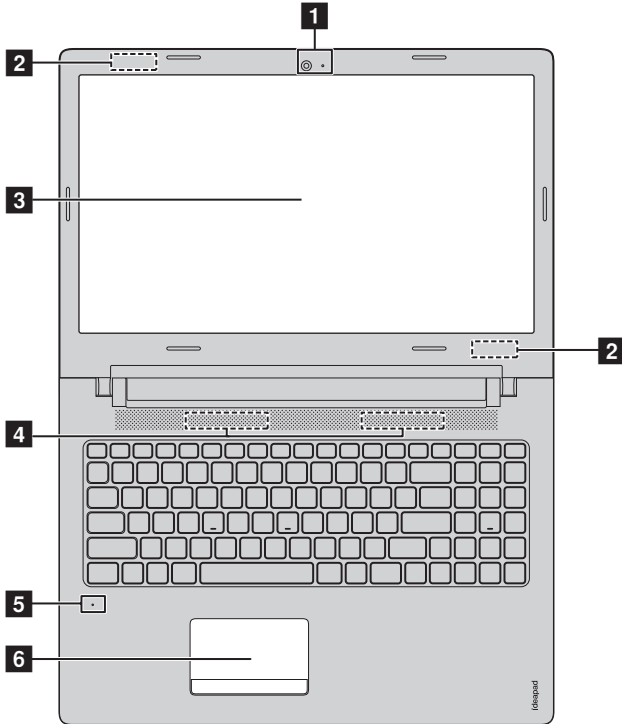

Note: The dashed areas indicate parts that are not visible externally.

⦿ Attention:

- Do *not* open the display panel beyond 180 degrees. When closing the display panel, be careful *not* to leave pens or any other objects in between the display panel and the keyboard. Otherwise, the display panel may be damaged.

Chapter 1. Getting to know your computer

- 1 Integrated camera (on select models)** Use the camera for video communication.
- 2 Wireless LAN antennas** Connect to a wireless LAN adapter to send and receive wireless radio signals.
- 3 Computer display** The LCD display with LED backlight provides brilliant visual output.
- 4 Speakers** Provide audio output.
- 5 Built-in microphones** Capture sound which can be used for video conferencing, voice narration, or audio recording.
- 6 Touch pad** The touch pad functions as a conventional mouse.

Touch pad: To move the pointer on the screen, slide your fingertip over the pad in the direction in which you want the pointer to move.

Touch pad buttons: The functions of the left/right side correspond to those of the left/right mouse button on a conventional mouse.

Note: You can enable/disable the touch pad by pressing **F6** ().

Chapter 1. Getting to know your computer

■ Using the keyboard

Your computer has a numeric keypad and hotkeys incorporated in its standard keyboard.

Numeric keypad

The keyboard has a separate numeric keypad. To enable or disable the keypad, press the Numeric Lock key (**Num Lock**).

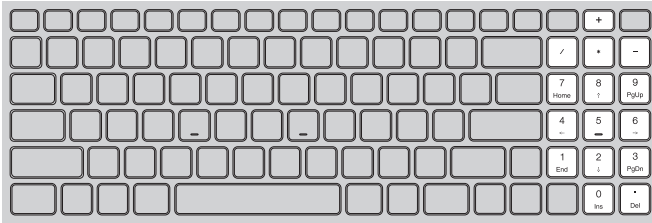

Chapter 1. Getting to know your computer

Hotkeys

You can access certain system settings quickly by pressing the appropriate hotkeys.

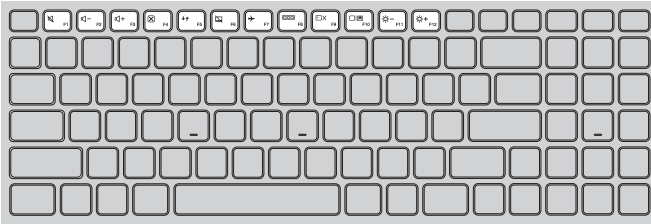

Mutes/unmutes the sound.



Enables/disables Airplane mode.



Decreases the volume level.



Displays all currently active apps.



Increases the volume level.



Turns on/off the backlight of the LCD screen.



Closes the currently active window.



Toggles the display between the computer and an external device.



Refreshes the desktop or the currently active window.



Decreases display brightness.



Enables/disables the touch pad.



Increases display brightness.

Note: If you changed the **Hotkey Mode** from **Enabled** to **Disabled** in the BIOS setup utility, you will need to press the Fn key in combination with the appropriate hotkey.

Left-side view

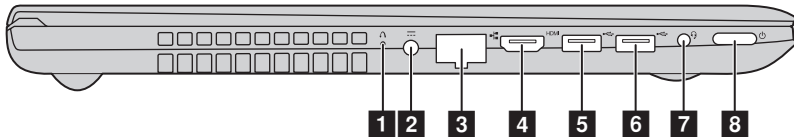

- 1 Novo button** When the computer is off, press this button to start the Lenovo OneKey Recovery system or the BIOS setup utility, or to enter the boot menu.
- 2 AC power adapter jack** Connects to the AC power adapter.
- 3 RJ-45 port** Connects the computer to an Ethernet network.
- 4 HDMI port** Connects to devices with HDMI input such as a TV or an external display.
- 5 USB 2.0 port** Connects to USB devices.

Note: For details, see “Connecting USB devices” on page 6.

- 6 USB 3.0 port** Connects to USB devices.

Note: For details, see “Connecting USB devices” on page 6.

- 7 Combo audio jack** Connects to headsets.

Notes:

- The combo audio jack does not support conventional microphones.
- The recording function may not be supported if third-party headphones or headsets are connected, due to different industry standards.

- 8 Power button** Press this button to turn on the computer.

Chapter 1. Getting to know your computer

■ Connecting USB devices

You can connect a USB device to your computer by inserting its USB plug (Type A) into the USB port on your computer.

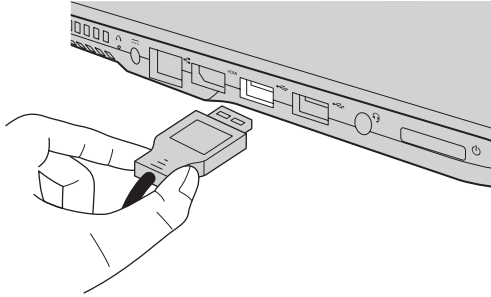

The first time you plug a USB device into a particular USB port on your computer, Windows automatically installs a driver for that device. After the driver has been installed, you can disconnect and reconnect the device without performing any additional steps.

Note: Typically, Windows detects a new device after it has been connected, and then installs the driver automatically. However, some devices may require you to install the driver before connecting. Check the documentation provided by the device's manufacturer before connecting the device.

Before disconnecting a USB storage device, make sure your computer has finished transferring data to that device. Click the **Safely Remove Hardware and Eject Media** icon in the Windows notification area to remove the device before disconnecting.

Note: If your USB device uses a power cord, connect the device to a power source before connecting it. Otherwise, the device may not be recognized.

■ Using memory cards (not supplied)

Your computer supports the following types of memory cards:

- Secure Digital (SD) card
- Secure Digital High Capacity (SDHC) card
- SD eXtended Capacity (SDXC) card
- MultiMediaCard (MMC)

Notes:

- Insert *only* one card in the slot at a time.
- This card reader does not support SDIO devices (e.g., SDIO Bluetooth, etc.).

Inserting a memory card

Insert the memory card until it touches the bottom of the slot.

Removing a memory card

Gently pull the memory card out of the memory card slot.

Note: Before removing the memory card, disable it by using the Windows safely remove hardware and eject media utility to avoid data corruption.

Chapter 1. Getting to know your computer

■ ■ Right-side view

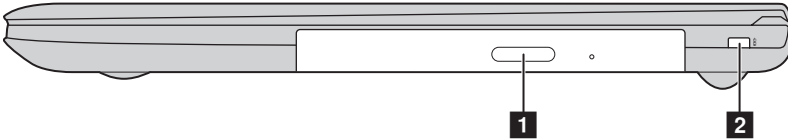

- 1 Optical disc drive** Reads/burns optical discs.

Note: Some models are supplied with a dummy optical disc drive.

- 2 Kensington slot** Attach a security lock (not supplied) here to help protect your computer from theft and unauthorized use. You can attach a security lock to your computer to help prevent it from being removed without your permission. For details on installing the security lock, please refer to the instructions shipped with the security lock that you have purchased.

Front view

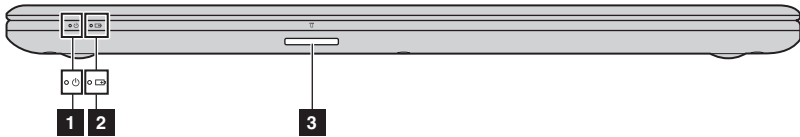

1 Power status indicator

2 Battery status indicator

Indicator	Indicator status	Meaning
Battery status indicator	On (solid white)	The battery has more than 20% charge.
	Solid amber	The battery has between 5% and 20% charge.
	Fast blinking amber	The battery has less than 5% charge.
	Slow blinking amber	The battery is being charged. When battery charge reaches 20%, the blinking color changes to white.
	Slow blinking white	The battery has between 20% and 80% charge and is still charging. When the battery reaches 80% charge the light will stop blinking, but charging will continue until the battery is fully charged.
Power status indicator	On (solid white)	The computer is powered on.
	Blinking	The computer is in sleep mode.
	Off	The computer is powered off.

3 Memory card slot Insert memory cards (not supplied) here.

Note: For details, see “Using memory cards (not supplied)” on page 7.

Chapter 1. Getting to know your computer

■ ■ Bottom view

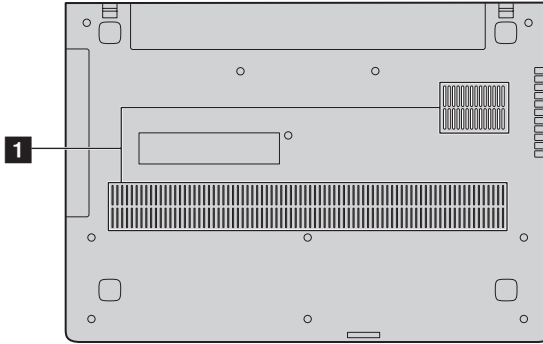

- 1** **Ventilation slots** Allow air to enter the computer for cooling.

Chapter 2. Lenovo OneKey Recovery system

The Lenovo OneKey Recovery system is software designed to back up and restore your computer. You can use it to restore the system partition to its original status in case of a system failure. You can also create user backups for easy restoration as required.

Notes:

- If your computer is preinstalled with a GNU/Linux/DOS operating system, OneKey Recovery system is not available.
- To utilize the features of the OneKey Recovery system, your hard disk already includes a hidden partition by default to store the system image file and the OneKey Recovery system program files. This default partition is hidden for security reasons, which explains why the available disk space is less than the stated capacity.

■ Backing up the system partition

You can back up the system partition to an image file. This image file can be used to restore the system partition. To back up the system partition:

- ① In Windows, press the Novo button or double-click OneKey Recovery icon to start the Lenovo OneKey Recovery system.
- ② Click **System Backup**.
- ③ Select a back-up location and click **Next** to start the backup.

Notes:

- You can choose a back-up location on the local hard disk drive or an external storage device.
- Remove the removable hard disk drive before starting the Lenovo OneKey Recovery system. Otherwise, data from the removable hard disk drive might be lost.
- The back-up process may take a while.
- The back-up process is only available when Windows can be started normally.

Chapter 2. Lenovo OneKey Recovery system

■ Restoring

You can choose to restore the system partition to its original status or to a previously created back-up point. To restore the system partition:

- ❶ In Windows, press the Novo button or double-click OneKey Recovery icon to start the Lenovo OneKey Recovery system.
- ❷ Click **System Recovery**. The computer will restart to the recovery environment.
- ❸ Follow the on-screen instructions to restore the system partition to its original status or to a previously created back-up point.

Notes:

- The recovery process is irreversible. Make sure to back up any data you wish to save on the system partition before starting the recovery process.
- The recovery process may take a while. So be sure to connect the AC power adapter to your computer during the recovery process.
- The above instructions should be followed when Windows can be started normally.

If Windows cannot be started, then follow the steps below to start the Lenovo OneKey Recovery system:

- ❶ Shut down the computer.
- ❷ Press the Novo button. From the **Novo Button Menu**, select **System Recovery** and press Enter.

Chapter 3. Troubleshooting

■ ■ Frequently asked questions

This section lists frequently asked questions by category.

■ Finding information

What safety precautions should I follow when using my computer?

The *Lenovo Safety and General Information Guide* which came with your computer contains safety precautions for using your computer. Read and follow all the precautions when using your computer.

Where can I find the hardware specifications for my computer?

You can find hardware specification for your computer on the printed flyers which came with your computer.

Where can I find warranty information?

For the warranty applicable to your computer, including the warranty period and type of warranty service, see the Lenovo limited warranty flyer that came with your computer.

■ Drivers and preinstalled software

Where are the installation discs for Lenovo preinstalled software (desktop software)?

Your computer did not come with installation discs for Lenovo preinstalled software. If you need to reinstall any preinstalled software, you can find the installation program on the C or D partition of your hard disk. If you cannot find the installation program there, you can also download it from the Lenovo consumer support website.

Where can I find drivers for the various hardware devices of my computer?

If your computer is preinstalled with a Windows operating system, Lenovo provides drivers for all the hardware devices that you need on the C or D partition of your hard disk. You can also download the latest device drivers from the Lenovo consumer support website.

Chapter 3. Troubleshooting

■ Lenovo OneKey Recovery system

Where are the recovery discs?

Your computer did not come with recovery discs. Use the Lenovo OneKey Recovery system if you need to restore the system to its factory status.

What can I do if the back-up process fails?

If you can start the backup but it fails during the back-up process, try the following steps:

- ❶ Close all open programs, and then restart the back-up process.
- ❷ Check to see if the destination media is damaged. Select another path and then try again.

When do I need to restore the system to its factory status?

Use this feature when the operating system fails to start up. If there is critical data on the system partition, back it up before starting recovery.

■ BIOS setup utility

What is the BIOS setup utility?

The BIOS setup utility is ROM-based software. It displays basic computer information and provides options for setting boot devices, security, hardware mode, and other preferences.

How can I start the BIOS setup utility?

To start the BIOS setup utility:

- ❶ Shut down the computer.
- ❷ Press the Novo button and then select **BIOS Setup**.

How can I change the boot mode?

There are two boot modes: **UEFI** and **Legacy Support**. To change the boot mode, start the BIOS setup utility and set boot mode to **UEFI** or **Legacy Support** on the boot menu.

When do I need to change the boot mode?

The default boot mode for your computer is **UEFI** mode. If you need to install a legacy operating system, such as Windows, Linux or Dos, etc (that is, any operating system before Windows 8) on your computer, you must change the boot mode to **Legacy Support**. The legacy operating system, such as Windows, Linux or Dos, etc cannot be installed if you don't change the boot mode.

■ Getting help

How can I contact the customer support center?

See "Chapter 3. Getting help and service" in the *Lenovo Safety and General Information Guide*.

■ ■ Troubleshooting

Display problems

When I turn on the computer, nothing appears on the screen.

- If the screen is blank, make sure that:
 - The AC power adapter is connected to the computer, and the power cord is plugged into a working electrical outlet.
 - The computer power is on. Press the Power button again for confirmation.
- If these items are set correctly, and the screen remains blank, have the computer serviced.

When I turn on the computer, only a white cursor appears on a blank screen.

- Restore backed-up files to your Windows environment or the entire contents of your hard disk to its original factory contents using the Lenovo OneKey Recovery system. If you still see only the cursor on the screen, have the computer serviced.

The screen goes blank while the computer is on.

- Your power management is enabled. Do one of the following to resume from sleep mode:
 - Press any key on the keyboard.
 - Press the Power button.
 - Press the Windows button.
 - Press **F9** () to confirm whether the backlight of the LCD screen has been turned off.

Sleep problems

The critical low-battery error message appears, and the computer immediately turns off.

- The battery power is getting low. Connect the AC power adapter to the computer.

The computer enters sleep mode immediately after Power-on.

- Make sure that:
 - The battery is charged.
 - The operating temperature is within the acceptable range. See “Chapter 2. Use and care Information” in the *Lenovo Safety and General Information Guide*.



Note: If the battery is charged and the temperature is within range, have the computer serviced.

The computer does not return from sleep mode and the computer does not work.

- If your computer is in sleep mode, connect the AC power adapter to the computer, then press the Windows button or the Power button.
- If the system still does not return from sleep mode, your system has stopped responding, and you cannot turn off the computer; reset the computer. Unsaved data may be lost. To reset the computer, press and hold the Power button for eight seconds or more. If the computer still does not reset, remove the AC power adapter.

Display panel problems

The screen is blank.

- Do the following:
 - If you are using the AC power adapter or the battery, and the battery status indicator is on, press **F12** () to make the screen brighter.
 - If the power indicator is blinking, press the Power button to resume from sleep mode.
 - Press **F9** () to confirm whether the backlight of the LCD screen has been turned off.
 - If the problem persists, follow the solution in the next problem “The screen is unreadable or distorted.”

The screen is unreadable or distorted.

- Make sure that:
 - The screen resolution and color quality are correctly set.
 - The monitor type is correct.

Incorrect characters appear on the screen.

- Is the operating system or programs installed correctly? If they are installed and configured correctly, have the computer serviced.

Sound problems

No sound can be heard from the speakers even when the volume is turned up.

- Make sure that:
 - The Mute function is off.
 - The combo audio jack is not being used.
 - Speakers are selected as the playback device.

Chapter 3. Troubleshooting

Battery problems

Your computer shuts down before the battery status indicator shows empty.

-or-

Your computer operates after the battery status indicator shows empty.

- Recharge the battery.

A hard disk drive problem

The hard disk drive does not work.

- In the **Boot** menu in BIOS setup utility, make sure that the hard disk drive is included in the **UEFI** correctly.

Other problems

Your computer does not respond.

- To turn off your computer, press and hold the Power button for eight seconds or more. If the computer still does not respond, remove the AC power adapter.
- Your computer might lock when it enters sleep mode during a communication operation. Disable the sleep timer when you are working on the network.

The computer does not start from a device you want.

- See the **Boot** menu of the BIOS setup utility. Make sure that the **UEFI** in the BIOS setup utility is set so that the computer starts from the device you want.
- Also make sure that the device from which the computer starts is enabled. In the **Boot** menu in the BIOS setup utility, make sure that the device is included in the **UEFI** list.
- While powered-off, press Novo button to select the device you want the computer starts from.

The connected external device does not work.

- Do *not* connect or disconnect any external device cables other than USB while the computer power is on. Otherwise, you might damage your computer.
- When using high power consumption external devices, such as an external USB optical disk drive, use an external device power adapter. Otherwise, the device may not be recognized, or the system may shut down as a result.

Appendix A. CRU instructions

■ ■ Removing the keyboard

To remove the keyboard, do the following:

- 1 Turn off the computer. Disconnect the AC power adapter and all cables from the computer.
- 2 Close the computer display, and then turn the computer over.
- 3 Remove the screws that secure the keyboard 1.

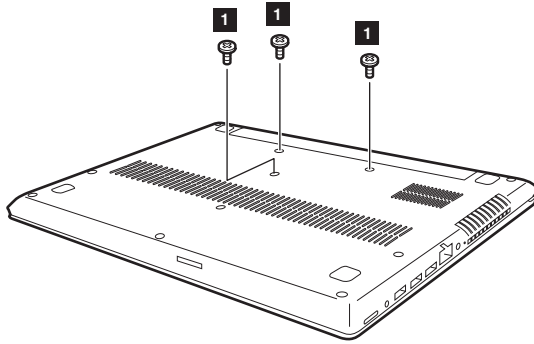

- 4 Turn the computer over, and then open the computer display.
- 5 Push the keyboard with the tip of an unfolded paper clip (or similar object without a sharp tip) through the screw hole on the back cover.
- 6 Loosen the keyboard with fingers 2, and then lift the keyboard slightly 3.

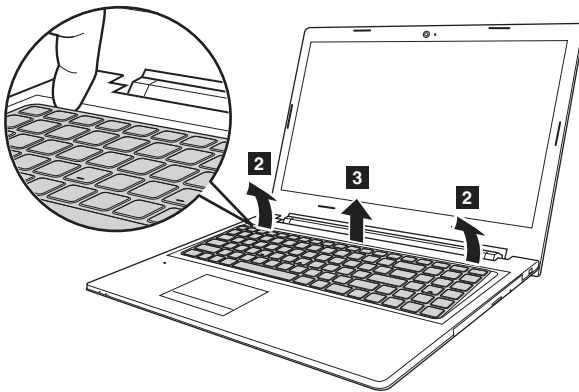

Appendix A. CRU instructions

- 7 Disconnect the keyboard connector in the direction shown by arrows **4** and **5**. Then remove the keyboard.

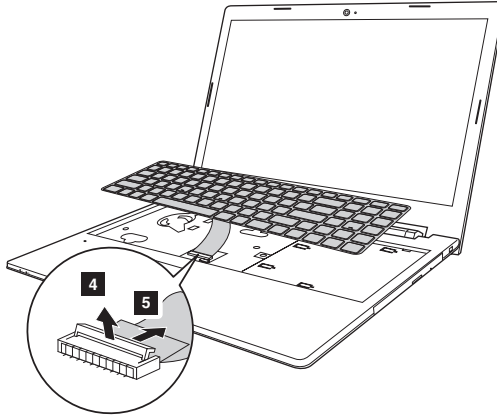

■ ■ Removing the optical drive

To remove the optical drive, do the following:

- 1 Remove the keyboard. For details, see “Removing the keyboard” on page 19.
- 2 Remove the screw shown in the illustration 1.
- 3 Gently pull the optical drive out 2.

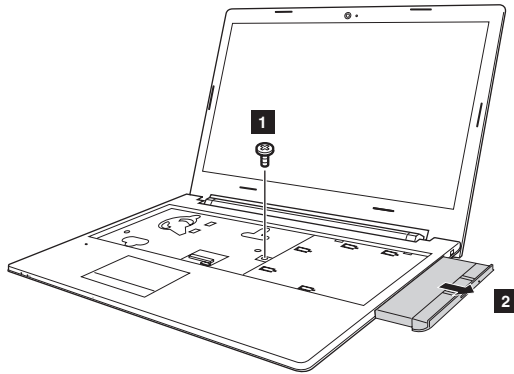

- 4 Remove the screw 3, then remove the optical drive bracket in the direction shown by arrow 4.

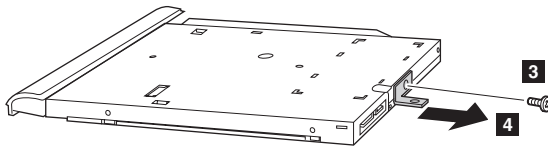

Appendix A. CRU instructions

- 5 Carefully remove the optical drive bezel in the direction shown by arrow 5.

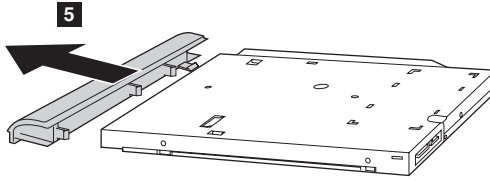

The following table provides a list of CRUs (Customer Replaceable Units) for your computer and informs you of where to find replacement instructions.

	Safety, Warranty, and Setup Guide	User Guide
AC power adapter	O	
Keyboard		O
Optical drive		O

Trademarks

The following terms are trademarks or registered trademarks of Lenovo in the United States, other countries, or both.

Lenovo

OneKey

Microsoft and Windows are trademarks of Microsoft Corporation in the United States, other countries, or both.

Other company, products, or service names may be trademarks or service marks of others.

